

quest 2.5

ADJUSTABLE BASE



**OWNER'S MANUAL**

Safety Precautions and Usage Statements .....	1-3
Parts List .....	4
Base and Remote Overview .....	5
Quick Reference Guide .....	6
Installation Guide .....	7-9
Remote Control .....	10-11
Pairing the Remote .....	12
Connecting Strap (Not Included) .....	13
Syncing Two Bases (Optional) .....	14
The Wand Voice Activated System .....	15
The Wand Voice Commands .....	16-17
Headboard Bracket Installation Guide (Optional) .....	18
Battery Backup Strap .....	19
Troubleshooting .....	20
Note .....	21

## Attention: Important Safety Disclaimers

Read the following information before using this product. Failure to use a surge protection device could compromise safety or cause product malfunction and could void the electrical portion of your warranty.

### TO REDUCE THE RISK OF SHOCK, BURNS, FIRE OR INJURY:

For optimal safety and operation, plug bed base into a surge protector (not included). The bed base should only be plugged directly into a wall outlet or surge protector (strongly recommended). Always unplug the base from the electrical outlet before servicing any part of the base. To reduce risk of electric shock, unplug the base before cleaning. To safely disconnect, ensure the base is in a flat position with all motors off, and unplug from power source. Keep the power cord away from heated surfaces. Never operate the base when the air openings are blocked. Keep air openings free of lint, hair and the like. Do not drop or insert any object into any opening. Discontinue use of the bed base and contact a qualified service center if: it has a damaged cord or plug, if it is not working properly, or it has been dropped into water. Only use this bed base for its intended use as described in this manual. Do not use accessories/ attachments that are not recommended by the manufacturer. Close supervision is required when the bed base is used by or near children, convalescents, disabled persons or pets. Improper connection of the equipment can result in the risk of electrical shock, electrical fire or faulty operation of this bed base. If the plug does not fit your outlet, contact a qualified electrician to install a suitable outlet. Unauthorized modification or failure to use a wall outlet or surge protector could void the electrical portion of your warranty.

### PETS AND CHILDREN:

Immediately dispose of all packing materials as it may pose a smothering risk to small children and pets. To avoid injury, it is not advised to allow children and small pets to play on or under the bed. Children should not operate the bed base without adult supervision.

### PACEMAKERS:

Some products contain Neodymium MAGNETS which may interfere with devices such as pacemakers, ICD's and any other device sensitive to magnetic fields. It is STRONGLY recommended that owners of such medical devices consult their physician prior to using products that contain Neodymium MAGNETS. It is also possible that some pacemakers may falsely interpret the optional massage feature vibrations as movement/exercise. This is a common occurrence with any product that creates a vibrating movement and may not affect the pacemaker. Please consult your physician before using the massage feature.

### IN-HOME USE AND HOSPITAL STANDARDS:

Ergo adjustable bed bases are designed solely for in-home use. This base was not designed as a hospital bed and is not designed to meet hospital standards. Do not use this base with TENT TYPE oxygen therapy equipment or near explosive gases.

### ADDITIONAL SAFETY FEATURES

Casters (optional leg accessory) are equipped with locking wheels to prevent unwanted movement. Even when locked and unable to roll, it is possible for the casters to slide. Free release head and foot motors are designed to lower the mattress by retracting only with gravity, never pulling downwards, which minimizes pinch points

### LIFTING/LOWERING MECHANISMS

The lift/lower feature will emit a minimal humming sound during operation. This is normal. During operation, the lift arm wheels make contact with the platform support of the base. This contact may result in metal on metal or metal on plastic contact. This applies slight tension on the moving components and resonance is reduced to a minimum level. If excessive noise or vibration is experienced, reverse the movement action

# safety precautions and usage statements

(up or down) of the base with the remote control. This should realign the base's activating mechanisms to the proper operational position. In normal base operation, the wheels, which allow the bed to maintain its distance from the wall, will make contact with the steel platform supports of the base creating a contact noise. When entering, exiting or shifting weight on the base, this contact noise may be audible as the wheels make contact. This is normal.

## MATERIALS

Ergo adjustable bases are constructed from various materials including woods, metals, plastics and fabrics. Tension, pressure or movement applied to the frame, platform or shroud through general use may create an audible sound.

## MASSAGE OPERATION AND LOCATION ENVIRONMENT

The massage feature will emit a tone during operation. This is normal. As the massage intensity level is increased, the tone will intensify. The volume of this tone is directly related to the location environment. For example, when demonstrated in a show room, the surrounding environmental noise will cover some of the massage noise. However, when installed in a home setting with wooden floors, carpeted or not, the massage volume will be more noticeable. To minimize this resonance, place a piece of carpet, or rubber caster cups, under each leg or caster of the base. It is possible to experience vibration or noise from the exterior bed frame, headboard brackets, headboards or footboards if mounting bolts are not firmly tightened.

Levels 1-6 of massage intensity represent the revolutions of the motor per minute. Level 6 provides the maximum number of RPMs. However, this does not mean that the feeling of vibration is the strongest. Depending on the mattress material, thickness, and positioning of the user, the feeling of vibrations will differ. We encourage the user to find the massage intensity setting that suits them best. It is important to understand the physics of vibrations. Just as an engine may run rough

during idle, as the RPMs increase, the vibrations change concurrently.

## TOLERANCE

All Ergo adjustable foundations, depending on make and model, are designed and manufactured to perform and function within designated quality control parameters. Bases are subject to meticulous and rigorous inspections during the quality control process to ensure bases will operate within these standards during normal operating use. Normal operating use is defined as the following: Adjustable foundation is to be operated with a mattress and load. Testing procedures require lifetime cycle tests with up to 120kg distributed load. The angle (designated " $\alpha$ " in figure 1) between the back section and the flat section for various configurations of the mattress support platform shall be  $\pm 3^\circ$ , which translates to a tolerance of up to  $1\frac{1}{2}''$ .

The angle (designated " $\beta$ " in figure 1) between the flat section and foot section for various configurations of the mattress support platform shall be  $\pm 3^\circ$ , which translates to a tolerance of up to  $\frac{3}{4}''$ . Any adjustable foundation deemed to be within these allocated tolerances is considered to have met the manufacturer's quality control standards.

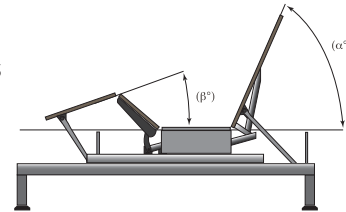

## THAT "NEW PRODUCT" SMELL:

Some people notice a slight odor to their new adjustable base—this can come from our material manufacturing process. This smell is normal and usually disappears before the product reaches you. Sometimes, however, this smell may still be noticeable. It usually disappears after a few weeks, providing adequate ventilation of the product and the environment.

## BREAK IN PERIOD:

You can speed up the break-in period by simply spending time in the adjustable bed through activities such as reading, watching TV or playing

# safety precautions and usage statements

with the kids or grandkids. The extra movement will help the adjustable base respond to weight and temperature changes. Some of the materials in our adjustable bases such as the woods, metals and plastics used in the platform, frame and components are sensitive to moisture content and temperature and may make sounds in colder environments.

## PAIRED OPERATION:

When operating a "paired" split base setup there may be a time latency up to 1.5 seconds between each bases articulation.

## WEAR AND TEAR:

Wear and tear is damage that naturally and inevitably occurs as a result of normal use or aging.

## FABRIC CARE:

To prolong the life of your fabric, protect from direct sunlight whenever possible. For spot cleaning, wipe area with a light damp sponge or vacuum with a soft brush attachment to remove particles. Keep at a minimum of 30cm (12 inches) away from direct heat sources. For a deeper cleaning, blot liquid spills with a clean dry cloth. Wipe with a clean cloth dampened with warm water. Do not wet excessively. A soft bristle brush may be used to remove ingrained soil. Avoid scratching by gentle brushing. Wipe with a clean cloth dampened with warm water to remove residues. Dry in shade away from direct heat. If persistent marks remain visible after cleaning, seek professional advice.

## PRODUCT RATINGS:

The lift motors are not designed to operate continuously for more than [2] minutes in an [18] minute time period or approximately 10% duty cycle. Attempting to circumvent or exceed this rating will shorten the life expectancy of the product and may void the warranty. The massage motors are not designed to operate continuously for more than 30 minutes at a time. Please allow the massaging system to rest for 30 minutes after automatic massage shut off before restarting.

## WEIGHT LIMITS:

This product is not rated to support weights in excess of 750 pounds. The base will structurally support this weight, provided it is evenly distributed across the bed base. The adjustable base is not designed to support or lift this amount in the head or foot sections alone. Exceeding this weight restriction could damage the bed and/or cause injury and will void the warranty.

## SAVE THESE INSTRUCTIONS.

## FCC Compliance:

**NOTE:** This equipment has been tested and found to comply with the limits for a Class B digital device, pursuant to part 15 of the FCC Rules. These limits are designed to provide reasonable protection against harmful interference in a residential installation. This equipment generates, uses and can radiate radio frequency energy and, if not installed and used in accordance with the instructions, may cause harmful interference to radio communications. However, there is no guarantee that interference will not occur in a particular installation. If this equipment does cause harmful interference to radio or television reception, which can be determined by turning the equipment off and on, the user is encouraged to try to correct the interference by one or more of the following measures:

- Reorient or relocate the receiving antenna.
- Increase the separation between the equipment and receiver.
- Connect the equipment into an outlet on a circuit different from that to which the receiver is connected.
- Consult the dealer or an experienced radio/TV technician for help.

Before discarding the packing materials - ensure all the parts are accounted for.

**All electronics and components that need to be installed are located in boxes under the base or attached to the frame.**

- A) Wireless Remote Control (1)
- B) Mattress Retainer Bar (1)\*
- C) Legs (6)
- D) Power Cord (1)
- E) Power Supply (1)
- F) Sync Cord ‡
- G) Battery Backup Strap (1)  
(2) 9V Batteries (not included)
- H) Connecting Strap‡

**Misc Parts (not included):**

- I) Surge Protector









**Headboard Bracket Components (Optional):**







- J) Headboard Bracket (2)†
- K) T-Bracket (2)†
- L) Spacer (2)†
- M) Long Bolts (8)†
- N) Short Bolts (10)†
- O) Nuts (18)†

\* These items are attached to the base for shipping purposes. Carefully remove from base and set aside.

‡ Only included in Twin Long and Cal King Split bases.

† This is an optional item and can be purchased (1-844-534-3676)

A)		B)*		C)	
D)		E)		F) ‡	
G)		H) ‡		I)	

HEADBOARD BRACKET COMPONENTS (Optional)					
J)†	K)†	L)†	M)†	N)†	O)†
					

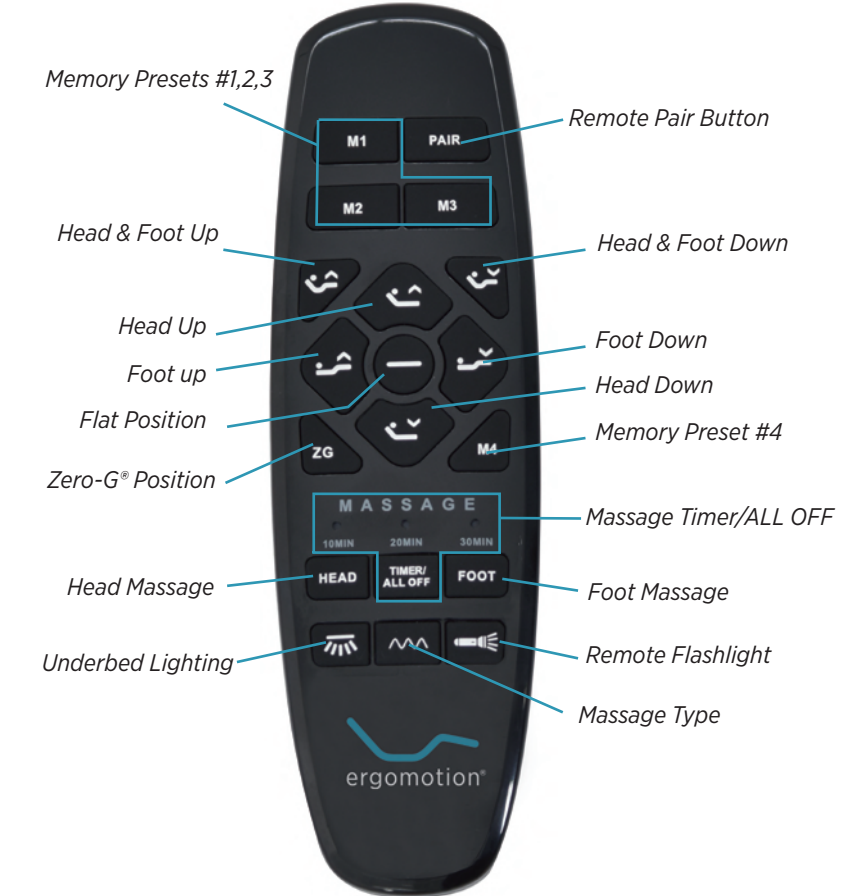
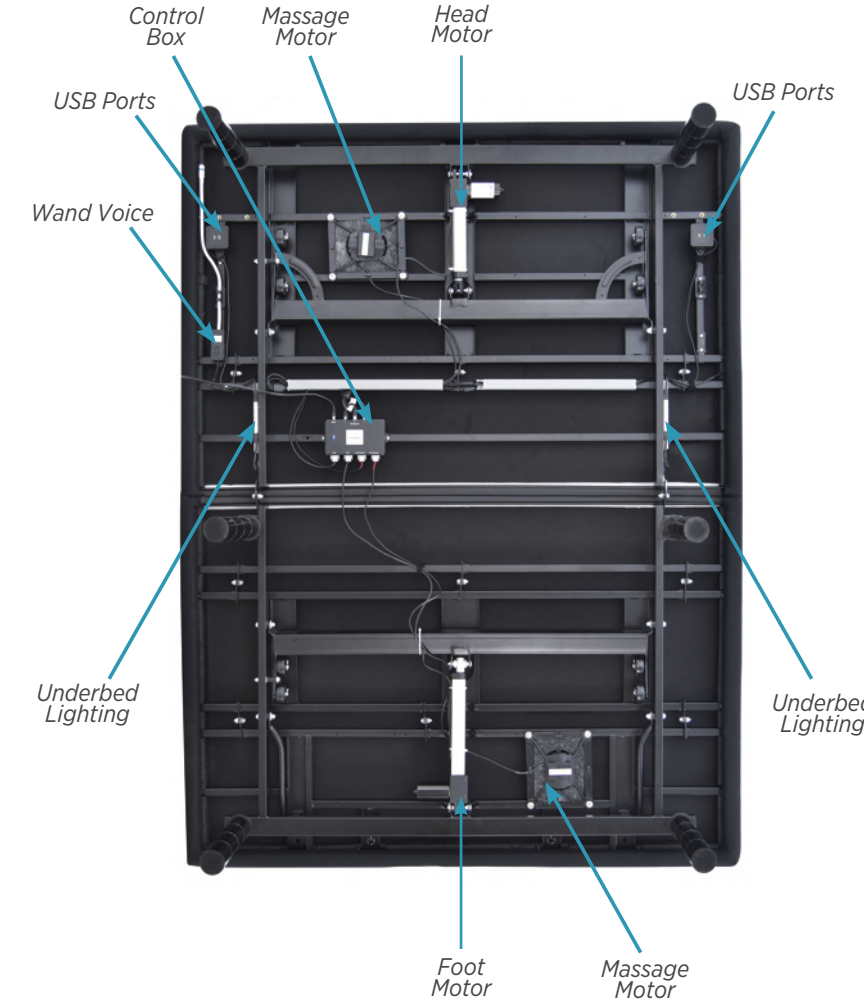



Not to scale. For illustration purposes only. Read all instructions before beginning installation.

## ELECTRONICS OVERVIEW

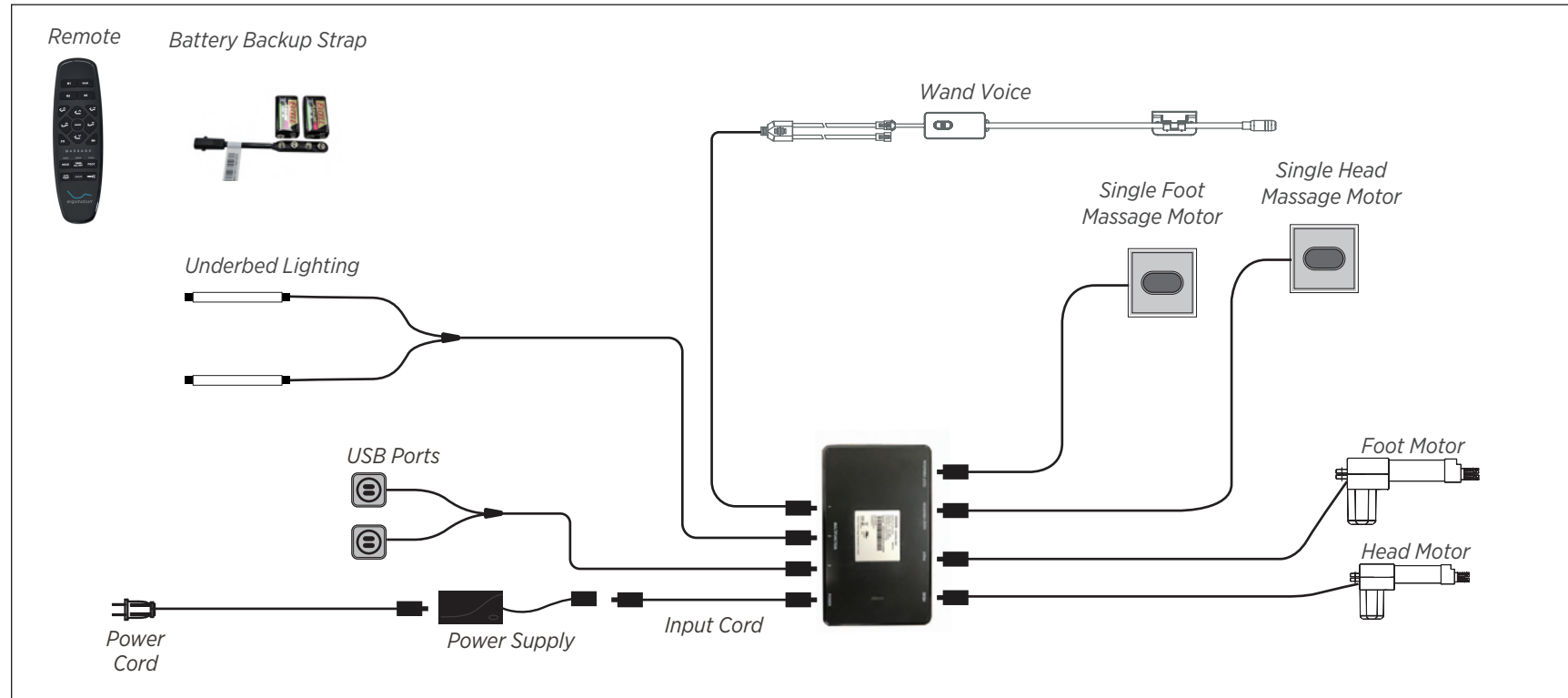

If installing a split unit, see pages 14.

Always use two people when setting up the base.

**1** With the help of an able-bodied assistant, place the carton on the floor with the arrows pointing downwards. Remove the binding straps and packing materials, making sure not to puncture the box with any sharp objects.

**2** Remove the bed base from the box keeping the bottom of the base facing upwards.

**3** If you need to change the offline voice location, the steps are as follows:

**Step 1:** Firstly, remove the offline voice tube from the card slot.



**Step 2:** Disconnect the wand to the control box cable via the 3-pin connector.



**Step 3:** Press down the Mounting Bracket (Figure A); at the same time slide back the offline voice box as shown in Figure B to remove the offline voice box.

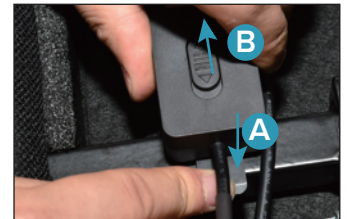

**Step 4:** After removing the offline voice box, when installing on the other side, slide the wand device onto the mounting bracket until you feel it click into place.



# installation guide

**Step 5:** Connect The Wand to the Control Box Cable via the 3-pin connector.



**Step 6:** Snap the hose into the slot.

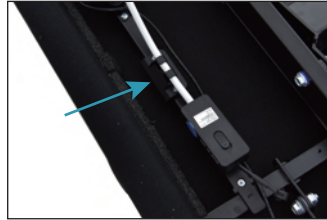

**4**

Legs are shipped fully assembled. Alternative heights in 3" increments can be achieved by removing leg segments.

To install the legs, thread the washer over the bolt of the leg with the recessed side facing the leg, and tighten by hand. Do not over tighten.



**5**

Uncoil the Input Cord (connected to control box's Power port) and plug it into Power Supply.



**6**

Insert the Power Cord into the Power Supply.



**7**

Carefully flip the base over on to its legs. Important: Two people are required to move the bed base. Do not drag across the floor. Do not rest frame on its side, excessive pressure may damage the legs. Adjust the offline voice hose to the appropriate position.



# installation guide

**8**

Plug the power cord into a power source.  
**A surge protector is recommended.**



**9**

Quickly test remote functions to verify proper setup before placing mattress on base. Return the base to a flat position before placing the mattress on top.

**10**

Place each end of the mattress retainer bar into the inserts at the foot of the base until the retainer bar is secured in place.



Setup is now complete! Test all functions on remote.

# remote control

## REMOTE OVERVIEW

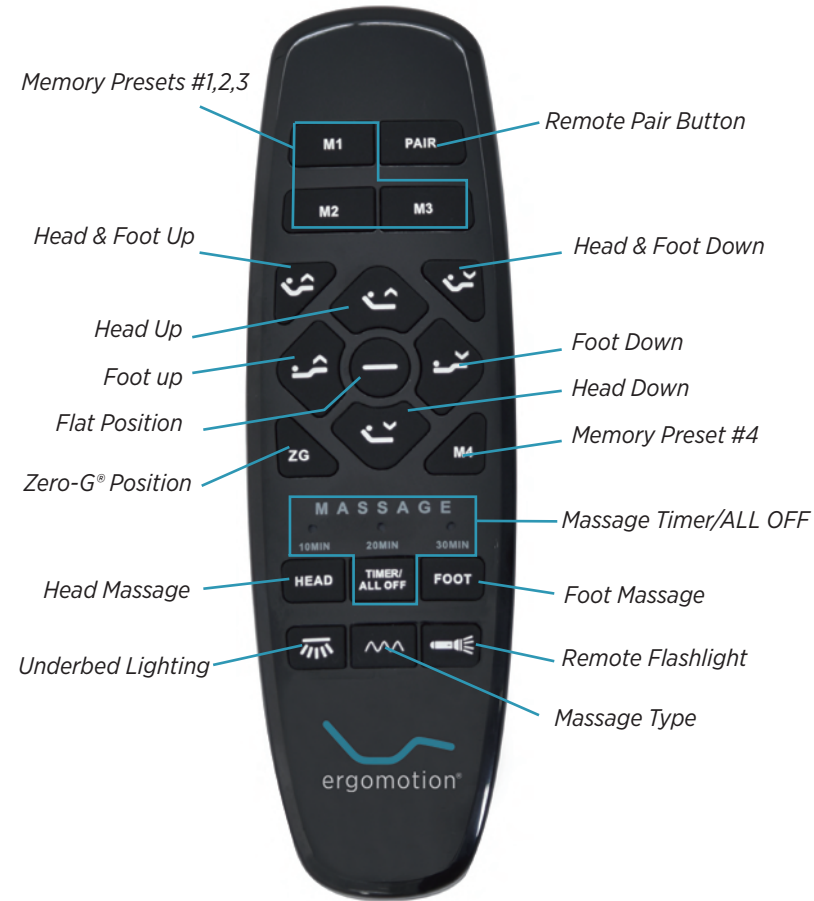

## ADJUST



The **HEAD** ▲ ▼ arrows lift and lower the head section of the base.



The **SYNC** ▲ ▼ arrows lift and lower the head & foot section of the base simultaneously.



The **FOOT** ▲ ▼ arrows lift and lower the foot section of the base.



One touch **ZERO G**® preset position. Zero G® adjusts your legs to a higher level than your heart helping to relieve pressure off the lower back and promote circulation.



One touch **FLAT** preset position.

# remote control

## MEMORY PRESETS



Memory Preset Position 1



Memory Preset Position 2



Memory Preset Position 3



Memory Preset Position 4

### TO PROGRAM THE PRESET POSITIONS:

Articulate the head and foot to your desired position. Next, press and hold one of the preset buttons [**MEMORY 1/2/3/4**] for 5 seconds. The position is now saved.

**NOTE:** To restore the preset buttons back to their original factory settings, hold **FLAT** and **ZERO-G** simultaneously for at least 5 seconds. The original presets will be restored.

## MESSAGE FEATURE



The **Head** + buttons adjust the head massage intensities.



The **Foot** + buttons adjust the foot massage intensities.



The **Timer/All Off** button selects 10, 20, or 30 minute massage interval. Pressing a fourth time will turn off massage.



The **Message Type** button toggles Pulse, Wave and Constant massage options.



The light on the top of the remote indicates a 10, 20 or 30 minute timer setting. Massage will automatically shut off after 10 minutes if the massage timer isn't set.

## LIGHTING



Turn the remote flashlight On/Off.



Used to turn the underbed lights On/Off.

# pairing remote control

The original remote that comes in the box is already paired to the adjustable base. No further action is required. In the event that the remote is not paired with the base, follow the steps below.

- 1 Unplug the Power Cord from your power outlet. Wait 1 minute, then plug it back in to your power outlet. Perform Step 2 within 10 seconds, while the control box light is flashing.

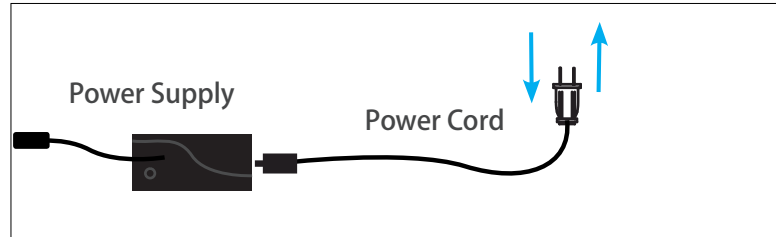

- 2 Hold the PAIR button on the remote, till the button backlight on the remote start flashing, at the same time the LED light on the control box will stop flashing, that means the pairing process is completed, please then release the pairing button.



- 3 Test all remote functions. If the remote buttons do not impact the adjustable base movements, please repeat the process again or call Ergomotion customer service: 1-888-550-3746

# connecting strap (not included)

If a split setup is being installed, optional plastic connecting straps can be used to help secure the bases together. To purchase optional accessories, please call 1-888-550-3746.

- 1 With the bases in their desired location, slightly loosen both legs to allow the strap to fit on the leg bolt, between the leg washer and frame.



- 2 Slide side (a) of the connecting strap onto leg bolt. Swing the strap and connect side (b) to the leg bolt. Secure the strap by shifting to the left.



- 3 Re-tighten legs. Do not over tighten. Use the remaining strap and repeat on other end of the base.



# syncing two bases (optional)

A Sync Cord is included with the base. Not available on Queen, Full or Full-Long size bases. The Sync Cord connects the two control boxes to a single remote for the synchronization of two bases. This process is most commonly used for syncing two connected TXL bases.

- 1 Unplug bases from power source.
- 2 Connect the Sync Cord to the Multifunction port of each Control Box.
- 3 Plug bases back into the power source.
- 4 Check to ensure all cords are securely attached. Both remotes will now operate both bases simultaneously.

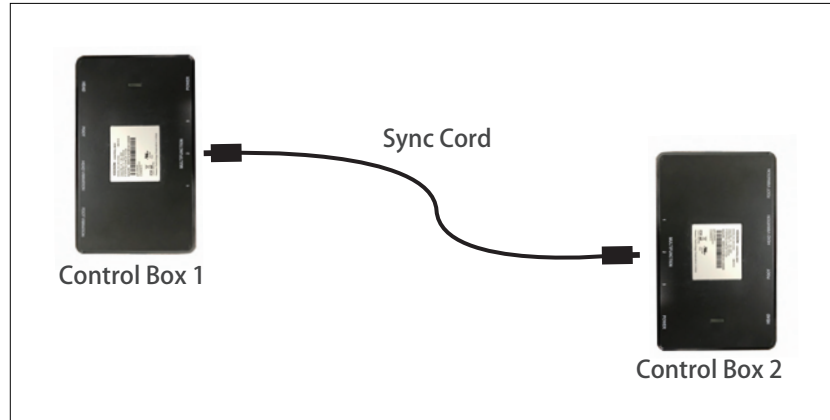

### PERFORMANCE NOTES

If bases become mismatched, returning the bases to the flat positions will re-sync the mechanical positions.

The system is now linked. Pressed buttons on either remote will control the two bases simultaneously.

# the wand voice activated system

Install The Wand to enable offline voice control of your adjustable base.



**ATTENTION:** Your adjustable base can pose an entrapment hazard which is increased in households with small children and or pets. Using voice controls further increases this entrapment hazard due to the potential of unintentionally triggering a command vocally. The voice controls could be unintentionally triggered by yourself, a small child, the television, a radio program, etc. and by using this product you agree that you have read and reviewed the commands, including the Emergency Commands, and acknowledge the increased entrapment risk associated with using voice commands.

If you agree with this statement please read the instructions on the following pages to learn how to setup **The Wand**, however if you have any questions in regard to the use of voice controls please contact customer service prior to activating **The Wand**.

# the wand voice commands



## SETUP DEVICE

The Wand Voice Activated system will arrive turned off and you will need to activate The Wand by selecting an invocation command of your preference. In order to activate The Wand and start using voice controls to control your adjustable base, please select one of the invocation phrases provided by moving the slider switch to either "ERGO" or "MOTION" on The Wand Voice dongle located underneath your base.

## WAKE UP DEVICE

To use The Wand Voice Activated System, simply say the invocation command you chose during setup, either "Hello Ergo" or "Hello Motion", which will activate the microphone for 8 seconds. This will be indicated by the blue light. While the microphone is active you can now use any of the voice commands listed below to control your adjustable base.

	VOICE COMMAND	EXPLANATION
EMERGENCY COMMANDS	STOP-MOVING	Stop all movement
	ALL-UP	Raise both the head & foot 6 seconds



## SAFETY INFORMATION

If you wish to stop using voice commands, you can turn the device off by switching the slider on the wand to the middle "OFF" position. Your adjustable base can pose an entrapment hazard and there is an increased risk for households with small children and or pets. Using voice controls increases this entrapment hazard due to the potential of accidentally triggering a command vocally. The voice controls could be unintentionally triggered by a small child, television, radio program, etc., please read the "Emergency Commands" section so that you are familiar with these commands in the event of an emergency.

# the wand voice commands

Once the invocation phrase has been uttered, the microphone will be active for 8 seconds which is indicated by the blue light. While the microphone is active you can now use any of the command utterances listed below to control your adjustable base.

	VOICE COMMAND	EXPLANATION		VOICE COMMAND	EXPLANATION
Common Instructions	GOOD-NIGHT	Flat bed	Massage Control	TURN-ON-MASSAGE	Turn on massage driver
	RISE-AND-SHINE	Adjust the bed to the preset position for Zero-G		TURN-OFF-MASSAGE	Turn off massage driver
	TV-TIME	Adjust the bed to the preset position for watching TV		MASSAGE-UP	Increase the massage strength
Actuators Control	RAISE-HEAD	Back actuator rises 3S	Head Massage	MASSAGE-DOWN	Decrease the massage strength
	LOWER-HEAD	Back actuator falls 3S		TURN-ON-HEAD-MASSAGE	Turn on head massage
	RAISE-FOOT	Foot actuator rises 3S		HEAD-MASSAGE-UP	Increase the head massage strength
	LOWER-FOOT	Foot actuator falls 3S	HEAD-MASSAGE DOWN	Decrease the head massage strength	
Preset	FLAT-PRESET	Flat bed	Foot Massage	TURN-ON-FOOT-MASSAGE	Turn on foot massage
	ANTI-SNORE	Adjust the bed to the preset position for antisnore		FOOT-MASSAGE-UP	Increase the foot massage strength
	ZERO-G/ ZERO-GRAVITY	Adjust the bed to the preset position for Zero-G	FOOT-MASSAGE-DOWN	Decrease the foot massage strength	
	LOUNGE-PRESET	Adjust the bed to the preset position for relax	Massage Mode	WAVE-ONE	Switch to massage mode 1
	FAVORITE-PRESET	Adjust the bed to the preset position for favorite one		WAVE-TWO	Switch to massage mode 2
	TV PRESET	Adjust the bed to the preset position for watching TV		WAVE-THREE	Switch to massage mode 3
			Save Preset Position	SAVE-LOUNGE	Set the current position to relax mode
				SAVE-FAVORITE	Set the current position to favorite mode
			Underlight Control	SAVE-TV	Set the current position to watching TV mode
		TURN-OFF-LIGHT		Turn off underlight	
			TURN-ON-LIGHT	Turn on underlight	

ENTRAPMENT HAZARD: This bed can crush and kill when it moves. Using voice controls may increase this risk. Review emergency commands before activating voice controls.

# headboard bracket installation guide (optional)

Headboard Brackets are an optional accessory.

A 9/16" (14 mm) & 1/2" (13 mm) socket and crescent wrench are necessary to complete installation.

1

- a.) Align the hole in the bracket to the brass sleeve into which the leg threads. Hold the bracket in place and screw the leg into the base until it is snug. **DO NOT OVERTIGHTEN.** Too much force may cause the leg to spin freely.
- b.) Align the tab with the hole in the frame (located towards the foot of the base) and use a short bolt and nut to secure the bracket. Make sure the bolt is tight.

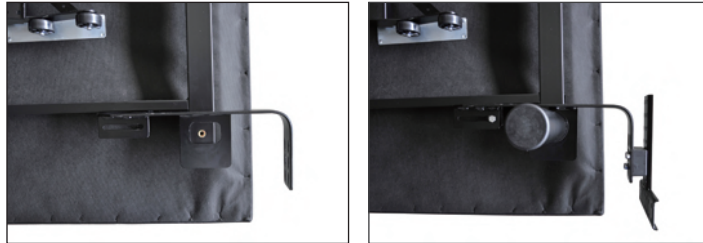

2

Attach the plastic spacer and T-Bracket.

- a.) Measure the distance between the mounting holes on the headboard and install the spacer and attachment plate to accommodate the headboard.
- b.) To install the plastic spacer and attachment plate, you will need (2) long bolts and (2) nuts. Place the spacer and attachment plate in the desired location and slip the bolts through the holes with the head of the bolt facing outward. Position the bolts diagonally on the spacer. Use the 9/16" socket and wrench to tighten the bolts.

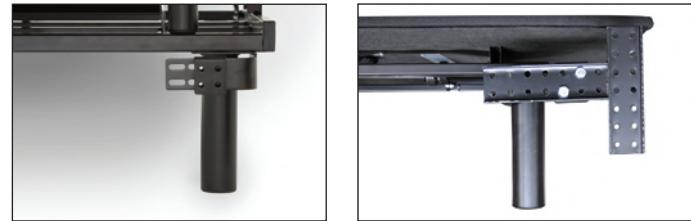

3

You may now connect your headboard to the attachment plates using the remaining short bolts and nuts to secure it to the brackets. The heads of the bolts will face outward. Use a 9/16" socket and 1/2" wrench to tighten the bolts.

# battery backup strap (optional)

For emergency use only, in case of a power outage.

Batteries are not to be used for normal operation of the bed.

1

Disconnect the Power Supply from the input power cord.

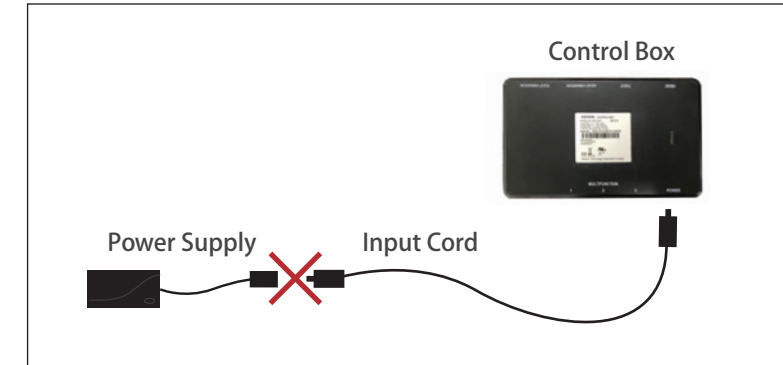

2

Connect the Battery Backup Strap to the (2) Alkaline 9 Volt batteries. Do not mix brand name Batteries.



3

Connect the end of the Battery Backup Strap to the input power cord that is attached to the control box.

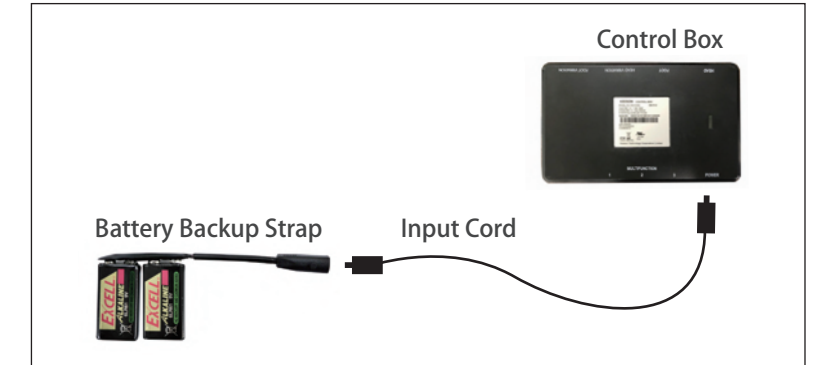

4

Use the remote to return the base to a flat position.

**Note:** Detach the Battery Backup Strap and reconnect the power supply after the emergency is over, as the system will continue to draw power from the batteries even if not in use.



