

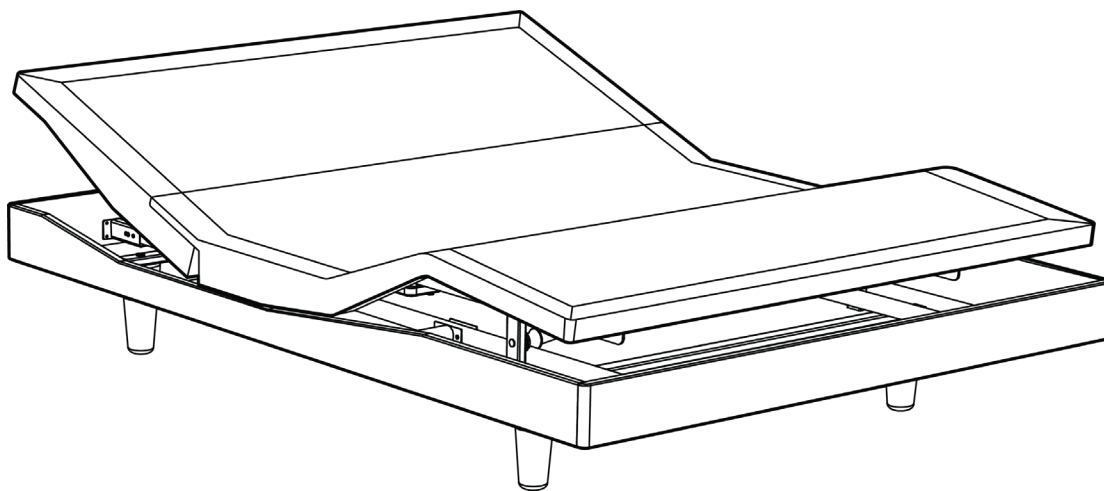

Adjustable Power Base R650™ Owners Manual



*Image may not represent the product you purchased

CONGRATULATIONS ON YOUR PURCHASE OF A REVERIE POWER BASE!

Follow the steps listed below to operate your Reverie power base using the remote provided and/or the Reverie Nightstand™ app.

Step 1: Download the Reverie Nightstand™ app from the App store for any of your Apple devices, or from the Google Play store for any Android devices.

Step 2: Fully charge your remote before use using the USB charging cable provided.

Step 3: Contact Reverie customer service at 1-800-973-8374 or customerservice@reverie.com for additional assistance.

Your base comes with a 20 Year Limited Warranty. For a Full Owners Manual, Warranty, and Troubleshooting information, please visit our website at: <https://reverie.com/support>

WARNING! IMPORTANT SAFETY INSTRUCTIONS. PLEASE READ THESE INSTRUCTIONS THOROUGHLY BEFORE USING THIS PRODUCT. SAVE THESE INSTRUCTIONS!

When using an electrical furnishing basic precautions should always be followed, including the following:

READ ALL INSTRUCTIONS BEFORE USING (THIS FURNISHING)

DANGER: To reduce the risk of electric shock: Always unplug this furnishing from the electrical outlet before cleaning.

WARNING:

To reduce the risk of burns, fire, electric shock, or injury to persons:

- Unplug from outlet before putting on or taking off parts.
- Close supervision is necessary when this furnishing is used by or near children, invalids or disabled persons.
- Use this furnishing only for its intended use as described in these instructions. Do not use attachments not recommended by the manufacturer.
- Never operate this furnishing if it has a damaged cord or plug, or if it is not working properly, dropped or damaged, or dropped into the water, call Reverie customer service.
- Keep the cord away from heated surfaces.
- Never drop or insert any object into any opening.
- Do not use outdoors.
- Do not operate where aerosol (spray) products are being used or where oxygen is being administered.
- To disconnect, turn all controls to the off position, then remove plug from outlet.

WARNING: Risk of Injury: Keep children away from under the head and foot of the base when moving.

WARNING: Risk of electric shock: Connect this furnishing to a properly grounded outlet only.

GROUNDING INSTRUCTIONS:

This product must be grounded. If it should malfunction or breakdown, grounding provides a path of least resistance for electric current to reduce the risk of electric shock. This product is equipped with a cord having an equipment-grounding conductor and a grounding plug. The plug must be plugged into an appropriate outlet that is properly installed and grounded in accordance with all local codes and ordinances.

DANGER:

Improper connection of the equipment-grounding conductor can result in a risk of electric shock. Check with a qualified electrician or serviceman if you are in doubt as to whether the product is properly grounded.

Do not modify the plug provided with the product. If it will not fit the outlet, have a proper outlet installed by a qualified electrician.

FOR BEST RESULTS, YOUR POWER BASE SHOULD BE PLUGGED INTO A SURGE PROTECTOR (not included).

This product is for use on a circuit having a standard rating of 120 volts and is factory equipped with a specific electric cord and plug to permit connection to a proper electric circuit. Make sure that the product is connected to an outlet having the same configuration as the plug. No adapter should be used with this product. If the product must be reconnected for use on a different type of electric circuit, the reconnection should be made by qualified service personnel.

Unauthorized modifications could void the electrical portion of your warranty. Failure to use a properly grounded outlet for this product or modification of the plug will compromise this important grounding safety feature and may result in electrical shock, electrical fire, or faulty operation of the product.

WARNING: PINCH POINT! Do not reach under the base during operation.

WARNING!

DO NOT USE NEAR PEOPLE USING OR WEARING MEDICAL DEVICES. FOR HOUSEHOLD / RESIDENTIAL USE ONLY. DO NOT USE OUTDOORS. This product conforms to UL STD 962

IMPORTANT SAFETY FEATURES:

Use this furnishing only for its intended use as described in these instructions. Do not use attachments not recommended by the manufacturer. If there is an overload weight condition on the head or foot mechanism, the control unit will automatically stop all functions. Once the excess weight is removed the control unit will automatically allow all functions to resume operation after 30 seconds. As with any product that produces a vibrating motion, it is possible that some pacemakers may interpret this motion as a false sense of movement and or exercise. This may or may not affect your pacemaker. If you have any concerns, please consult your physician. For more information please contact customer service by calling **800-973-8374**.

USER-SERVICEABLE PARTS:

This product is specifically designed to have no maintenance by you, the user. Therefore, you are encouraged not to open any motors, alter the wiring, adjust, modify or change the structure of the product, as it will void the warranty.

POWER RATINGS:

INPUT: AC 100-240V - 50/60Hz, 1.5 Amp
OUTPUT: DC 29V-2.24A

IN-HOME USE AND HOSPITAL DISCLAIMER:

Your power base is strictly designed for in-home use only. It is NOT designed for hospital use and is NOT designed to meet hospital standards. Do not use this base with TENT TYPE oxygen therapy equipment or near explosive gases.

SMALL CHILDREN AND PETS WARNING:

After your Power Base has been unboxed, immediately dispose of packaging as it can smother small children and pets. To avoid injury, children and pets should not be allowed to play on or under the power base.

Children should not operate this product without adult supervision. Close supervision is necessary when this furnishing is used by, or near children, invalids, or disabled persons.

SAVE THESE INSTRUCTIONS:

Your Power Base has been designed to provide you with the reliable operation and durability you expect. This product has been inspected and tested prior to shipment.

For best performance, you should enter and exit the Power Base while it is in the flat or fully lowered position.

DO NOT SIT ON THE HEAD OR FOOT SECTIONS WHILE IN THE RAISED POSITION.

INTENDED USAGE

The electric power base should be installed with the head board brackets and/or the head of the frame positioned close to a wall.

PRODUCT RATINGS

The lift motor in your Power Base is NOT designed for continuous use. Reliable operation and full life expectancy will be attained as long as the lift motor does not operate more than two (2) minutes over an eighteen (18) minute period, or approximately 10% duty cycle. Any attempt to circumvent or exceed this rating will shorten the life expectancy of this product and may void the warranty. The recommended weight restrictions for your Power Base is up to 850 lbs. total weight, including people and the mattress for all sizes of power bases. Lift speed will vary due to weight and mattress configuration, as well as the mattress type. The weight must be evenly distributed across the power base. This Product is not designed to support or lift 850 lbs of total weight in the head or foot sections of your Power Base alone, or in any unevenly distributed fashion. Some mattresses are not designed for Power Bases because they do not bend or flex well when adjusted. When using such a mattress with your Power Base the weight limits set forth herein do not apply, as the bending of the mattress requires significant force and puts significant strain on the motors and the Power Base itself.

WARRANTY PRECAUTION:

Do not open control box, motors or wireless remote controls (with the exception of the battery compartment if equipped). The warranty is void if these units are tampered with. Any repair or replacement of power base parts must be performed by an authorized technician.

Note: Exceeding the recommended weight restrictions could damage your power base and void your warranty and using a mattress on top of your power base that is not designed for adjustability may also void your warranty.

IMPORTANT UNPACKING INSTRUCTIONS

To avoid damage to the power base, always open the carton while the power base is laying in the FLAT position on the floor.

OPEN FLAT

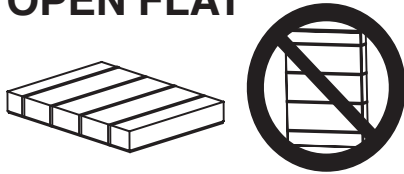

Package contents:

- Remote Control
- Retainer Bars & Hardware
- Base Legs
- Allen Wrench
- Wireless Charging Pad (optional accessory)

STEP 1

Carefully pull the folded power base unit out of the shipping carton. Remove and discard the plastic bag. Unfold the base keeping the unit top side down. For safety reasons, this should be performed by 2 people.

WARNING: PACKAGING MATERIAL MAY SMOTHER SMALL CHILDREN AND PETS

STEP 2

Assemble the power base legs. Screw them in a clockwise direction into the threaded holes in the frame.

STEP 3

Remove the zip ties securing the excess cord from the motors of the power base.

STEP 4

Carefully flip the power base over with 2 people, to the topside-up position.



ATTENTION! Improper handling

DO NOT lean the power base against the installed legs to flip it over.



STEP 5

Remove the plastic packaging from the power base. If there is a yellow packaging band attached to the frame, remove this as well.

WARNING: Remove the yellow packaging bands from under the frame before attempting to operate the bed.

STEP 6

Plug the power cord into a grounded electrical outlet.

WARNING: POWER CORDS MUST NOT INTERFERE WITH ANY POWER BASE MECHANISMS.

NOTE: An electrical surge protection unit is recommended (not included)

STEP 7

Use the Retainer Bolts and Retainer Bar Plates to fasten the Mattress Retainer Bracket to the power base.

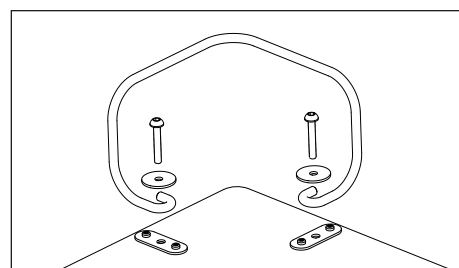

NOTE: Use only a manual screwdriver to install the retainer bolts. DO NOT use a power screwdriver to tighten the bolts.

STEP 8

If you are installing a headboard, proceed to follow the Headboard Bracket Assembly Guide on our website. If not, place your mattress on top of the power base. Power base assembly is now complete.

Emergency Power Down Feature

Your power base has an emergency lowering feature in the event that your power base is in the raised position and has lost power due to a power outage. Your base includes a built in battery supply that is intended only for use with this feature.

NOTE: DO NOT raise the base when powered with only backup batteries. The batteries are only intended to lower the base in case of emergency.

Register Online. For easy registration of your warranty visit <https://reverie.com/register-your-warranty>

Please prepare a digital copy of your proof of purchase (invoice or sales receipt) when registering online. You may be required to provide the Serial Number for registration, you can find it on the Law Tags attached to the base.

Manufactured by Reverie®
For Warranty and Service:
1-800-973-8374
customerservice@reverie.com
Please have your receipt ready and available.

Thank you and enjoy your power base.
www.reverie.com

Your remote is already paired with your power base. Follow the below instructions for replacement remote pairing.

CONNECTING TO ONE BED (does not include KING or SPLIT KING bed sizes)

STEP 1

Hold Lightbulb button for 3 seconds to start searching.

[Remote only detects 1 bed]

The remote will only detect one control box and automatically connect. Connection is now complete and will be taken back to the home screen.

STEP 2

[Remote detects multiple control boxes, this usually means you have more than one bed in your house]

Select Other

STEP 3

The screen now asks if you are connecting to only 1 bed. Select YES

STEP 4

There should now be a list of available control boxes that you can connect to. Scroll using any of the up/down buttons H/T/F. Select desired control box by single-pressing the lightbulb button. Once the single bed is selected, you will then be taken back to the home screen.

KING only

STEP 1

Hold Lightbulb button for 3 seconds to start searching.

STEP 2A

Select KING
If the remote detects only 2 control boxes then the remote will automatically connect to both control boxes on your bed.

STEP 2B

If the remote detects more than 2 control boxes, there should now be a list of available control boxes that you can connect to. (this usually means you have more than one bed in your house) Scroll using any of the up/down buttons H/T/F. Select the 2 desired control boxes by single-pressing the lightbulb button.

SPLIT KING only

STEP 1

Hold Lightbulb button for 3 seconds to start searching.

STEP 2

Select SPLIT KING
When you choose SPLIT KING, will be asked if want to connect to both sides of bed? Select YES or NO

STEP 3A

Select YES
If the remote detects only 2 control boxes then the remote will automatically connect to both sides of your bed.

If the remote detects more than 2 control boxes, there should now be a list of available control boxes that you can connect to. (this usually means you have more than one bed in your house) Scroll using any of the up/down buttons H/T/F. Select the 2 desired control boxes by single-pressing the lightbulb button. You will then be taken back to the home screen.

STEP 3B

Select NO
There should now be a list of available control boxes that you can connect to. Select the desired side of the bed you want to connect to by single-pressing the lightbulb button. You will then be taken back to the home screen.

CONNECTING TO TWO SEPARATE BEDS

STEP 1

Hold Lightbulb button for 3 seconds to start searching.

STEP 2

Select Other

STEP 3

The screen now asks if you are connecting to only 1 bed. Select NO.

STEP 4

There should now be a list of available control boxes that you can connect to, select the beds you wish to connect to [remote can show up to 20 beds] Select any two beds you wish to connect by single-pressing the lightbulb button. After selecting 2 beds, the remote will send the user to the home screen.

FOR PAIRING TWO REMOTES TO EACH SIDE OF THE BED

(for KING, SPLIT KING or two beds)

Our remote and Bluetooth technology allows for pairing/connecting two remotes with each side of the bed so each remote can control both sides of bed. Pair/Connect one remote with both sides of the bed, then wait for that remote to enter sleep mode and pair/connect the other remote with both sides of bed. If two remotes are connected to one bed, in order to actively use one of the remotes to control the bed you must make sure the other remote is in sleep mode. Waking up other remote will result in a disconnection from the control unit and the remote will show "No Bed Paired".

Remote Control Operation Guide

HEAD AND FOOT ADJUSTMENTS (A,C)

Adjusts the head and foot sections to the desired positions.

LUMBAR, TILT, OR PILLOW (B)

Your base includes 1 of 3 features; Lumbar, Tilt, Pillow Tilt, or no feature. Lumbar adjusts the lumbar support on your bed. Tilt slightly tilts your bed forward or backward. Pillow tilt adjusts the pillow section of your bed.

ANTI SNORE (D)

Raises the HEAD slightly for easier breathing.

ZERO GRAVITY (E)

Allows your legs to be lifted to a position slightly above the chest, which enables blood flow to easily circulate back to the heart, thus reducing stress and fatigue.

FLAT (F)

Returns both head and foot to the flat position.

PROGRAMMABLE MEMORY POSITIONS (G,I)

You can store 2 personalized memory positions. Press and hold the Memory button for 5 seconds until the LED light flashes 3 times to store the setting. To recall a Memory Position, press the corresponding button.

NOTE: Do not hold the memory position for more than 5 seconds or the setting will overwrite.

NIGHTLIGHT ON/OFF (H)

Toggle the lightbulb button for on/off functions. The Nightlight button also functions as the pairing button.

DISPLAY SCREEN

A. RAISE & LOWER HEAD SECTION

B. VARIABLE THIRD FEATURE

C. RAISE & LOWER FOOT SECTION

D. ANTI - SNORE

E. ZERO GRAVITY

F. FLAT

G. MEMORY POSITION 1

H. NIGHTLIGHT ON/OFF (REMOTE PAIRING)

I. MEMORY POSITION 2

J. HEAD MESSAGE INTENSITY

K. WAVE MESSAGE PATTERN

L. STOP MESSAGE

M. FOOT MESSAGE INTENSITY

N. MICRO USB CHARGING PORT



HEAD AND FOOT MESSAGE CONTROLS (J,M)

Turns on the corresponding message unit and slowly increases or decreases message intensity.

NOTE: The message feature is designed to automatically shut off after 30 minutes of continuous use.

WAVE MESSAGE PATTERN (K)

Turns on both head and foot message motors to 4 different wave presets.

MESSAGE STOP (L)

Press to stop all message features.

NOTE: The lowest setting will turn off the corresponding message unit.

CHARGING PORT (N)

To charge remote, plug in the wall charger and connect to the micro usb port. Unplug and plug-in the remote again if you do not see a charging symbol on the screen. A flashing LED on the remote indicates low power status.

NOTE: Any control button on the remote will interrupt and stop the FLAT, ZERO-G, Anti-Snore and Memory Position presets.

NOTE: If the remote cannot detect any beds, then it will display NO BED FOUND.

NOTE: Screen will timeout after 5 seconds, 15 seconds if screen is auto-refreshing.

REMOTE LOCKOUT FEATURE (E,L)

We created the remote lockout feature to help owners prevent unintended use of the base.

Activating Remote Lockout

At the same time, press and hold the ZERO GRAVITY and STOP buttons for 3 seconds. The LED will flash twice to indicate activation. Pressing any buttons on the remote while in lockout mode will result in no movement from the power base.

Deactivating Remote Lockout

Repeat the same process, press and hold the ZERO GRAVITY and STOP buttons at the same time for 3 seconds. The LED will flash twice to indicate deactivation. The remote and power base will work normally.

ADDITIONAL REMOTE FEATURES:

- The buttons are back-lit when a button is pressed, to aid the visibility of the remote in low light environments.
- Customers can control the remote without facing the receiver (best transmission range is within 30 feet or 10 meters).
- The remote is equipped with a lithium-ion battery that can be recharged anytime with the included Micro USB wall charger adapter. Please fully charge your remote before operating for the first time. When remote is fully charged, the charging symbol will disappear.
- This Base uses a RF (Radio Frequency) remote control system.
- The included remote is already paired with your power base, so should be operational right out of the box. Please test some of the features to ensure functionality.
- Only replacement remote controls require pairing instruction on following pages. If you find that your remote is not paired with the bed, please follow those Bluetooth pairing instructions.

NOTE: This power base may have minor intermittent performance due to RF Interference. This is a normal operation of the power base and is not a defect.

NOTE: Please remember to recycle all electronics.

NOTICE: Changes or modifications not expressly approved by the party responsible for compliance could void the user's authority to operate the equipment.

IMPORTANT NOTE:

To comply with the FCC RF exposure compliance requirements, no change to the antenna or the device is permitted. Any change to the antenna or the device could result in the device exceeding the RF exposure requirements and void user's authority to operate the device.

NOTE: This device complies with part 15 of the fcc rules. Operation is subject to the following two conditions: (1) This device may not cause harmful interference (2) This device must accept any interference received, including interference that may cause undesired operation.

How to Download the App Software

STEP 1

Use your iOS mobile device to log into the APP STORE.

STEP 2

Type “**Reverie Nightstand**” in the search column.

STEP 3

Select the Reverie Nightstand app.



STEP 4

Click install to download the app.

NOTE: Once the App is installed, when you open the app the Bluetooth module will connect to your device automatically.

NOTE: Make sure the Reverie Nightstand App is the last app open on your phone before locking (putting your phone in sleep mode)

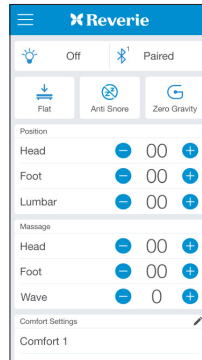

Dashboard/Home Screen

- Condensed versions of key features, functions and settings are accessible and controllable from the Dashboard - Nightlight, Bluetooth status, Reverie Presets, Position control, Massage control, Comfort Settings, Routines, Memory Positions, Alarms
- The Dashboard and each Preset Section is customizable to display your favorite and most used settings.
- Expandable Toolbar gives access to all app features - Dashboard, Position, Massage, Presets, Alarms, and Settings
- Nighttime Mode - Change the color scheme of the app to better suit nighttime use.

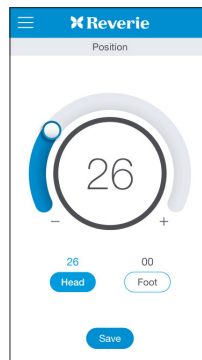

Position Control

- Control your head and foot elevation.
- Adjust your base using the Slider or press/hold the plus or minus symbols for micro adjustments.
- Switch between each adjustment (Head, Foot, Other) and view all settings above each button.
- Save your current position and/or massage setting as a new Comfort Setting.

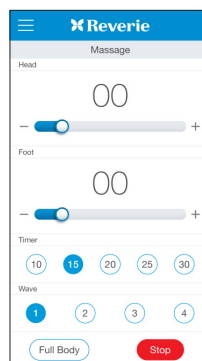

Massage

- Control your massage intensity using the Slider or press/hold the plus or minus symbols for micro adjustments.
- Full body - Turns on the full body function.
- Wave - Select one of 4 different wave functions
- Timer - Select your desired massage duration.
- Stop - Turns the massage off.

iOS App User Guide

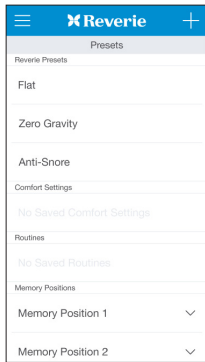

Presets

- Reverie Presets - Zero Gravity, Anti-Snore, and Flat.
- Comfort Setting - Press “+” to program a unique head, foot and/or massage combination.
- Routines - Press “+” to program a set of saved comfort settings into a series of timed positions.
- Memory Positions - Access and overwrite previously saved Memory Positions from your remote control.
- View details of each setting with the expand arrow as well as Edit and Delete.

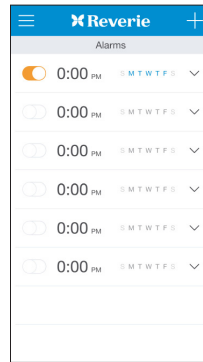

Alarm

- Create an alarm setting to raise and/or massage you awake.
- Press “+” to create a new alarm setting.
- Set time - Scroll to select the hour, minute and day.
- Repeat - Select the days of the week you would like the alarm to activate.
- Assign - Select a comfort setting or routine to assign the alarm to.

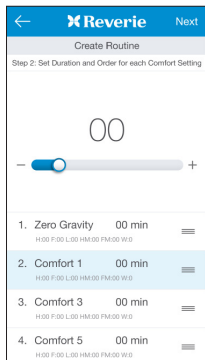

Routines

- Select which Comfort Settings you want to use to create a new Routine.
- Set the order of these Comfort Settings and the duration of each.
- Save your new Routine.

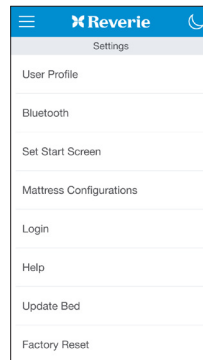

Settings

- Customize your app in settings.
- User Profile - Define your user profile to - The “Power Base” field is required and is important to allow the app to best represent your specific power base.
- Bluetooth - Shows the bed your app is connected to. Shows nearby beds that you can connect to in order of proximity.
- Reverie Connect - If your base is compatible with our Reverie Connect technology you can follow the setup to control your base with 9 voice activated commands
- Set Start Screen - Set what screen you want the app to open up to.
- Mattress Configurations - Reconfigure your Reverie Dream Supreme mattress with these firmness guides.
- Login/Logout - Log in to your account
- Help - Contact info for technical support.
- Update Bed - Update the software on your control box
- Factory Reset - Reset your app to original settings.

Android App User Guide

How to Download the App Software

STEP 1

Use your Android mobile device to log into the GOOGLE PLAY STORE.

STEP 2

Type “**Reverie Nightstand**” in the search column.

STEP 3

Select the Reverie Nightstand app.



STEP 4

Click install to download the app.

NOTE: When you open the app the Bluetooth module will connect to your device automatically.

NOTE: Make sure the Reverie Nightstand App is the last app open on your phone before locking (putting your phone in sleep mode)

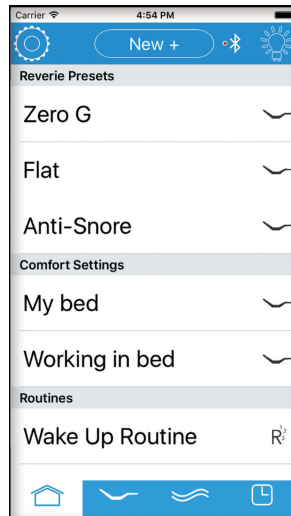

Home Screen

- Key features, functions and settings are accessible from the home screen.
 - Settings, Preset List, Comfort Settings, Routines, Bluetooth, Nightlight, Home Tab, Position Tab, Massage Tab, and Alarm Tab.
- Reverie Presets - Zero Gravity, Anti-Snore, and Flat are right at your fingertips.
- Comfort Setting - Press “New +” to program a unique head, foot and/or massage combination.
- Routines - Press “New +” to program a set of saved or new comfort settings into a series of timed positions.

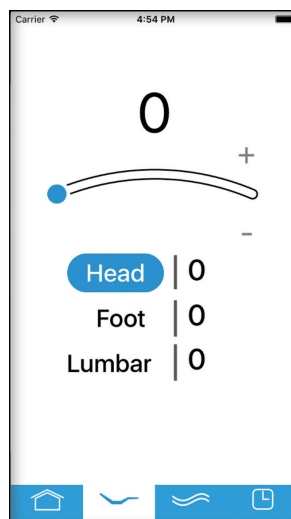

Position Control

- Control your head and foot elevation.
- Select the part of the bed you would like to elevate or lower (head or foot).
 - Use your finger to slide the blue dot along the curve to your desired elevation or press and hold the plus or minus symbol to adjust elevation.
- Your position on a scale of 1-100 will appear at the top of the screen and next to the head or foot position.

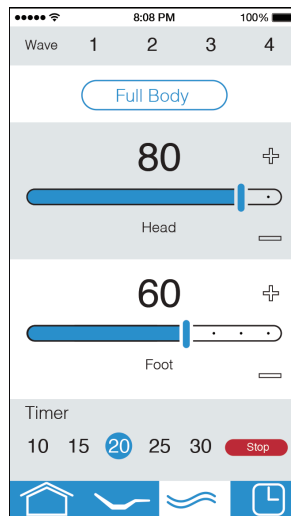

Massage

- Control your massage intensity and duration.
- Full body - Turns on the full body function.
- Wave - Select number of alternating pulses at the head and foot of the bed.
- Head and Foot control - Select massage intensity in the head and foot sections of the bed.
 - Use your finger to slide the blue button to your desired intensity or press and hold the plus or minus symbol to adjust intensity.
- Timer - Select your desired massage duration.
- Stop - Turns the massage off.

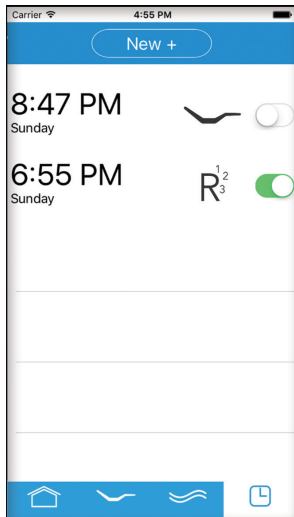

Alarm

- Create an alarm setting to raise and/or message you awake.
- Press “New +” to create a new alarm setting.
 - Set time - Scroll to select the hour, minute and day.
 - Repeat - Select the days of the week you would like the alarm to activate.
 - Bed control - Select nothing or select a new or existing comfort setting or routine.
 - Snooze - Enable snooze.

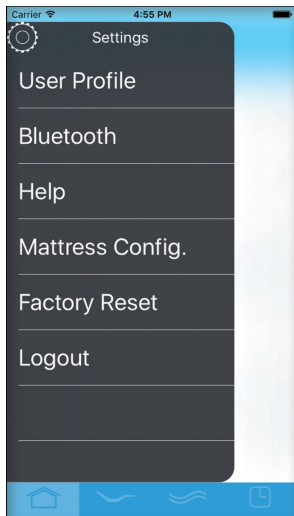

Settings

- Customize your app in settings.
- User Profile - Define your user profile to get recommendations on custom settings for you.
- Bluetooth - Shows the bed you are connected to and shows nearby beds that you can connect to in order of proximity.
- Help - Contact info for technical support.
- Mattress Configurator - Reconfigure your Reverie Dream Supreme mattress with these firmness guides.
- Factory Reset - Reset your app to original settings.
- Logout - Logout or create a new user.

Headboard Bracket Assembly

PARTS LIST

- A. Inner Headboard Brackets (2)
- B. Outer Headboard Brackets (2)
- C. Headboard Bracket Bolts (8)
- D. Washers (16)
- E. Lock Nuts (8)
- F. Wrench (1)
- G. Allen Key (1)

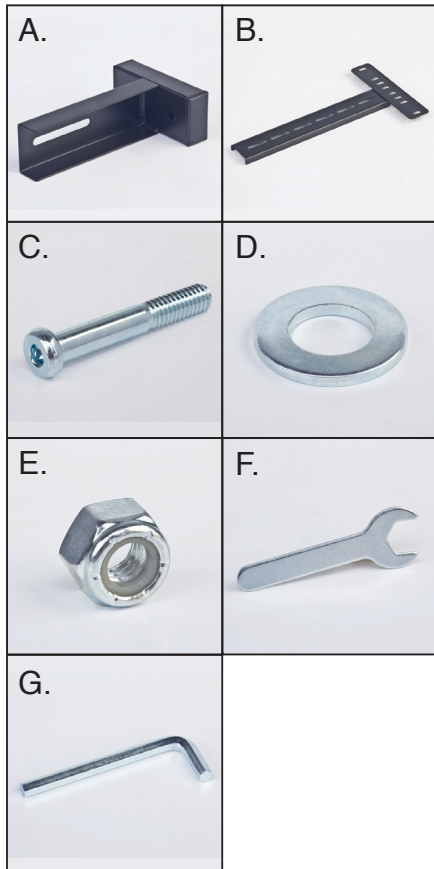

To prepare to install the headboard brackets to the power base, place one set of brackets on the left-hand side of the base and one set of brackets on the right-hand side of the base.

STEP 1

Use the remote control to raise the head of the base in order to gain access to the power base frame.

STEP 2

Bolt the Inner Headboard Bracket (A) to the headboard mount tube located on the steel frame crossbar using 2 Headboard Bracket Bolts (C), 2 Washers (D), and 2 Lock Nuts (E). Make sure the open end of the bracket is facing inward.

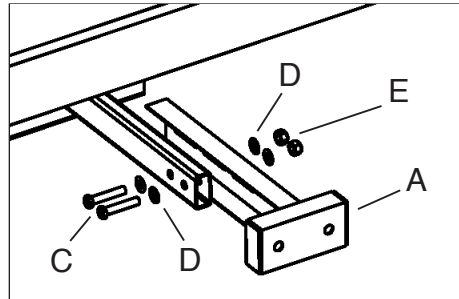

STEP 3

Place the open side of the Outer Headboard Bracket (B) onto the exposed square tube of the Inner Headboard Bracket (A). This will create a tight fit between (A) and (B). Place 2 Headboard Bracket Bolts (C) with a Washer (D) through the Outer Headboard Bracket (B) and into the Inner Headboard Bracket (A). Thread a Lock Nut (E) with a Washer (D) onto the bolts and hand tighten to allow for adjustment. Repeat steps 2-4 for the opposing side of the power base.

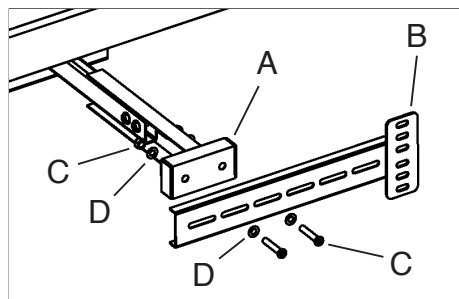

STEP 4

Lower the head section of your power base and check that there is sufficient distance between the edge of the power base and the Outer Headboard Brackets (B). Make adjustments if needed and firmly tighten the bolts attaching (B) to (A).

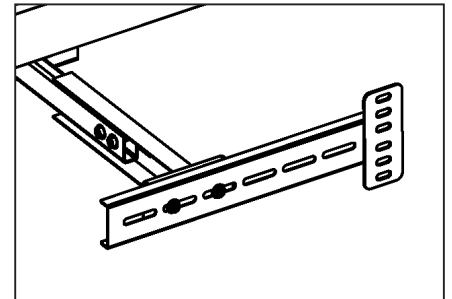

STEP 5

Measure the distance from each center of the mounting holes on your headboard.

Measure the distance from each center of the mounting holes in the Outer Headboard Brackets (B).

STEP 6

If the measurements do not match, loosen or remove the bolts that are holding the Outer Headboard Brackets (B) and shift them to be equal to the distance between your headboard mounting holes. Reinstall the bolts and firmly tighten.

STEP 7

Through the mounting holes in your headboard, fasten your headboard to the Outer Headboard Brackets (B) using additional hardware.

STEP 8

Place your mattress on top of your power base. Headboard Bracket Assembly is now complete.

Wireless Charging Pad

SPECIFICATION:

Size: 9.8 cm x 9.8 cm x 1.3 cm

Input Rating: 5V, 2A

Output Rating: 5V, 1.5A

Maximum Wireless Charging Current: 800mA

Wireless charging efficiency: around 75%

Net Weight: 110g

TO USE THE CHARGING PAD:

1. The charging pad should be placed near your bed on a flat surface.
2. Use the power adapter included in the box as power supply. Plug the power adapter into a wall outlet and plug the adapter USB cable into the Micro USB port of the pad.
3. The charging pad can be used to charge your Qi compatible devices such as cell phones. For proper alignment our charging point is located in the direct center of the pad.
4. The blue indicator light will flicker slowly when it's charging compatible devices.
5. The charging pad includes (2) built-in USB ports that can be used to charge devices such as the remote control, using the USB cable provided. We only recommend charging devices that require a 1A USB power output.

Important Safety Notes:

- The charging pad is for indoor use only.
- Do not use this charging pad in extremely hot, humid or corrosive environments to avoid circuit damage or other risks.
- Keep magnetic strips or chip cards (ID card, credit card, etc.) away from the charging pad to avoid magnetic failure.
- Do not place any metal parts on the charging pad.
- The charging pad is not a toy.
- Do not make any changes or modifications to the charging pad. Failure to comply will void the manufacturer's warranty.
- Do not use the charging pad if it has been damaged in any way.
- Please do not disassemble the charging pad.



Use the wireless charging pad to charge your personal compatible devices.



Charge your remote with the USB cable provided.

Troubleshooting

In the event the Power Base fails to operate, investigate the symptoms and possible solutions provided in the chart below:

SYMPTOM	SOLUTION
<p>No features of the Power Base will activate.</p>	<ul style="list-style-type: none"> • Make sure your remote is paired or plugged into the bed. • Your electrical circuit breaker may be tripped. • Verify the power cord is plugged into a working, grounded electrical outlet. <i>A grounded, electrical surge protection device is recommended.</i> Test the outlet by plugging in another working appliance. • This may be due to overload condition, remove the load and put the bed into the flat position and then move it all the way to maximum position to test that the functions are fully operational.
<p>Head or foot section will elevate but will not return to the horizontal (flat) position.</p>	<ul style="list-style-type: none"> • The power base mechanism may be obstructed. Elevate the power base and check for an obstruction. Remove the obstruction. • The head section may be too close to the wall. The headboard may be too close to the edge of the mattress. Adjust if required.
<p>Lift function has minor interference during operation.</p>	<ul style="list-style-type: none"> • There may be an overload of weight on your bed. • Press the lift buttons squarely & accurately. • The power base mechanism may be obstructed. Elevate the power base and check for an obstruction. Remove the obstruction.
<p>Excessive massage motor noise.</p>	<ul style="list-style-type: none"> • Make sure the massage motor cable is not loose and hitting the base structures. • Verify that the bed is not positioned against a wall, nightstand, or other object that may cause the vibration or noise. • If this base is installed over a bed frame, verify the massage motors are not causing the bed frame (or bed frame components) to vibrate. • Verify that the headboard attachment hardware is firmly tightened.
<p>Noise when operating the bed.</p>	<ul style="list-style-type: none"> • Check for obstructions under the bed. • The actuators make a light noise during operation, this does not indicate any defect. • Squeaking noise could be caused by a loose bolt. Identify and tighten the bolt. • If no solution can be found please call Customer Service.

Troubleshooting

Remotes only

SYMPTOM	SOLUTION
Remote Lockout Feature not working.	<ul style="list-style-type: none">• Make sure you are correctly pressing both specified buttons at the same time.• Verify that the remote has battery power.• Make sure there are no other devices causing RF interference with the remote.• If cannot determine then please call customer service.
Remote readout doesn't match actual bed position.	<ul style="list-style-type: none">• Recalibrate by pressing FLAT on the remote, then lift all sections to maximum position until it shows 100 on the remote screen.
Remote states "No Bed Paired".	<ul style="list-style-type: none">• Allow the remote to go back to sleep by setting down, check if its connected after 3 minutes.• If not resolved, go through the pairing process again.
Distorted image on the remote screen.	<ul style="list-style-type: none">• Let the remote go back to sleep and wake it up again. Repeat this multiple times. If problem persists, contact customer service.
Remote states PLC battery error.	<ul style="list-style-type: none">• Please call Customer Service.
Remote states other remote connected.	<ul style="list-style-type: none">• Either your phone is connected to the bed via the Reverie Nightstand app or another remote is connected. Disconnect from bluetooth in the app and make sure the other remote is asleep.

20 Year Limited Warranty

20 Year Limited Warranty for Reverie Power Bases

Ascion, L.L.C. d/b/a Reverie (hereinafter referred to as "Reverie") warrants to the end user (hereinafter referred to as "Purchaser") that during the twenty (20) year term of this Limited Warranty, Reverie will, at its sole discretion and option, repair or replace Purchaser's motorized bed frame or motorized bed foundation parts (hereinafter referred to as "adjustable power base" or "adjustable power bases") that are found to be defective due to faulty workmanship or materials, subject to the limitations set forth herein.

This Limited Warranty begins on the "warranty commencement date" which is the date of purchase for new unused adjustable power bases and the date of manufacture for adjustable power bases that have been used as floor or display models. Thus, on a floor model adjustable power base, the warranty is a portion of the 20-year Limited Warranty. If original proof of purchase is not provided by Purchaser, Reverie reserves the right to determine that the adjustable power base is not covered by this Limited Warranty or to use the manufacturing date as the warranty commencement date. This Limited Warranty extends only to the original Purchaser and may not be transferred.

YEAR 1: FULL COVERAGE OF PARTS AND LABOR

Upon receiving reasonable notice during the first year from the warranty commencement date, Reverie will send replacement parts (at no cost to the Purchaser) for any defective adjustable power base part to the Purchaser, and Reverie will pay all pre-authorized labor and transportation costs associated with the repair or replacement of any parts Reverie determines to be defective. This one (1) year Limited Warranty shall not apply if Purchaser does not return any and all defective parts to Reverie within 15 days of Purchaser's receipt of replacement part(s).

YEARS 2-5: FULL COVERAGE OF PARTS ONLY

Upon receiving reasonable written notice at any point in time that is more than one (1) year and up to five (5) years from the warranty commencement date, Reverie will offer replacement parts for any defective adjustable power base part to the Purchaser. This four (4) year Limited Warranty shall not apply if Purchaser does not return any and all defective parts to Reverie within 15 days of Purchaser's receipt of replacement part. Purchaser shall bear all service, transportation, labor and shipping costs related to the delivery and/or replacement of the defective part.

YEARS 6-20: FULL COVERAGE OF FRAME ONLY

Upon receiving reasonable written notice at any point in time that is more than five (5) years and up to twenty (20) years from the warranty commencement date, Reverie will offer replacement parts for any mechanical part of the frame found to be defective. Electronics, electrical components, drive motors and massage motors are excluded from this Limited Warranty. Purchaser shall bear all service, transportation, labor and shipping costs related to the delivery and/or replacement of the defective part.

ADDITIONAL TERMS AND CONDITIONS

This Limited Warranty does not apply: (a) to any damage caused by the Purchaser, including damage to or cracks in the remote or its LED screen, and peeling of the silicon rubber from remote; (b) if there has been any unauthorized repair or replacement of adjustable power base parts; (c) if the adjustable power base has been mishandled (whether in transit or by other means), subjected to physical or electrical abuse or misuse, or otherwise operated in any way inconsistent with the operation and maintenance procedures outlined in the Owner's Manual, this Limited Warranty, and any other applicable document published or approved by Reverie; (d) to damage to mattresses, fabric, cables, electrical cords or items supplied by any Reseller of the adjustable power base, (contact the Reseller or other relevant party for warranty information on these items.); (e) if there have been any unnecessary service calls, including costs for in-home service calls solely for the purpose of educating the consumer about the adjustable power base or for finding an unsatisfactory power connection.

This adjustable power base may include the ProGrip™ mattress retainer-less retention technology. Depending on the mattress used by the Purchaser, Purchaser may experience varying degrees of shifting of their mattress. Such shifting shall not be considered a defect under this Limited Warranty. Should shifting persist, please install the supplied retainer bars.

The Purchaser's adjustable foundation may be equipped with a lumbar support feature. When the lumbar support feature is articulated or any other portion of the adjustable foundation is in an articulated position, any use that results in weight being distributed unevenly across the entire top of the foundation may damage the adjustable foundation and shall void this warranty.

Repairs to or replacement of the adjustable power base or its components under the terms of this Limited Warranty will apply to the original warranty period and will not serve to extend such period.

The decision to repair or to replace defective parts under this Limited Warranty shall be made exclusively by Reverie in its sole and exclusive discretion.

REPAIR OR REPLACEMENT SHALL BE THE SOLE REMEDY OF THE PURCHASER. THERE SHALL BE NO LIABILITY ON THE PART OF REVERIE AND THEIR RESPECTIVE PARENTS, SUBSIDIARIES, DIVISIONS OR AFFILIATES FOR ANY SPECIAL, INDIRECT, INCIDENTAL, OR CONSEQUENTIAL DAMAGES OR FOR ANY OTHER DAMAGE, CLAIM, OR LOSS NOT EXPRESSLY COVERED BY THE TERMS OF THIS LIMITED WARRANTY.

This Limited Warranty does not include reimbursement for inconvenience, removal, installation, setup time, loss of use, shipping, or any other costs or expenses.

UNLESS OTHERWISE EXPRESSLY STATED IN THIS DOCUMENT, REVERIE AND THEIR RESPECTIVE PARENTS, SUBSIDIARIES, DIVISIONS AND AFFILIATES EXPRESSLY DISCLAIM ANY OTHER WARRANTY WHATSOEVER, EXPRESS OR IMPLIED, INCLUDING BUT NOT LIMITED TO IMPLIED WARRANTIES OF MERCHANTABILITY, FITNESS FOR A PARTICULAR PURPOSE, AND FREEDOM FROM DEFECTS AND WORKMANSHIP.

Some states may not allow the exclusion or limitation of incidental or consequential damages in some circumstances, so the above limitation or exclusion may not apply to every Purchaser. This Limited Warranty gives the Purchaser specific legal rights, and the Purchaser may also have other rights, which may vary from state to state. This Limited Warranty is valid in all states of the United States except Alaska, Hawaii and Puerto Rico.

If you experience any trouble with your adjustable power base during the warranty period, please consult the troubleshooting guide provided with your adjustable power base and online (if applicable), or the troubleshooting video provided online (if applicable). If problems persist after following these instructions, please call: 800-973-8374.

Please have your receipt ready and available. Thank you and enjoy your adjustable power base.